



an ISO 9001 : 2008
certified company



QUBE Rail

Factory : Plot No. 7, Survey No. 257, Nr. Secure Polymer,
Shapar (Veraval) 360 024, Dist. Rajkot, INDIA. Tel. : +91-281 6565678
E-mail : business@qubeindia.com | Web : www.qubeindia.com

Architectural Products
Catalogues



company profile

index

Who We Are ?

QUBE is a young and versatile organisation. With main focus on meaningful innovation, we serve at professional and consumer markets. In our entire portfolio, we demonstrate our innovation capacity by translating consumer insights into meaningful design and applications that improve the quality of people's lives.

QUBE is originated by three angle of brain experienced in Designing, Skilled craftsmanship and Marketing.

We at QUBE ensure optimum solutions in Stainless Steel Architectural with customised engineering as per design's requirement.

QUBE believe and stand on two facts points... good client relationship and supply on time.

QUBE strive for creative, quality and good team management to ensure the opportunities for new business and also eager to serve the existence clients.

We at QUBE, nurture our thoughts to meet the market trends with the help of our highly dedicated research and development team.

QUBE is committed, to the society at large, to serve with innovative, customised, cost control and maximum recycle process.

Working Methodology

Our working methodology is entirely based on the core values and its assessment. By which we can maintain our standards for conduct of business and behaviour of our entire colleague.

- **Value Addition**
Enhanced value addition for all our Stake Holders, Customer, Supplier, Employer, Society & Nation.
- **Personal Piloted**
Maintain quality attitude of personal and professional piloted.
- **Crystal Transparency**
Pursue all business dealing along crystal clear fact lines.
- **Research and Development**
We nurture to create the good environment for Research and Development.
- **Task on Date**
We frame our production with date and time to meet the quality and supply on time.

Vision

To be amongst the most trusted supplier of Stainless Steel Architectural products, in the range of Hand Rail, Hardware, Glass Fittings & Bathroom Accessories.

Mission

We wish to maintain our vision by adopting the quality production and lucrative design, to satisfy our client and consumers through our all experience.

Door & Window Concepts

Mortise Handle	06
Lock Body & Cylinder	18
Pull Handle	20
Hinges	26

Glass Concepts

Floor Spring	30
Patch Fitting	31
Glass Connector	34
Spider Fittings	36
Spider Routel	42
Routel & Fin Plates	44
Canopy Fittings	46

Bath Concepts

Bath Accessories	50
------------------	----

Stair Concepts

Balustrade & Hand Rails	58
-------------------------	----

an ISO 9001 : 2008 certified company



Open



Awesomeness

Sophistication has just acquired a new shape. Designed to perfection, the architectural range of hardware from RE comes with a promise to spellbind with its steely resolve for quality. Each article in this ensemble is a result of our continuous R&D as well as keen attention towards market trends.

Door & Window Concepts



IMH-01

Design : Ø19mm | Ø22mm
 Finish : Satin | Glossy
 Material : SS 304 | SS 316
 (Also available in Plate Type Mortise)

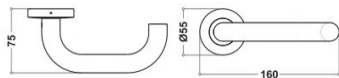

IMH-05

Design : Ø19mm | Solid 6 Pipe
 Finish : Satin | Glossy
 Material : SS 304 | SS 316
 (Also available in Plate Type Mortise)



IMH-02

Design : Ø19mm | Ø22mm
 Finish : Satin | Glossy
 Material : SS 304 | SS 316
 (Also available in Plate Type Mortise)

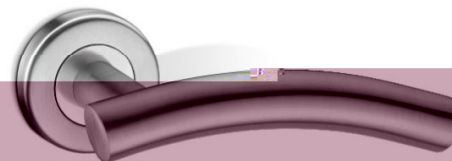
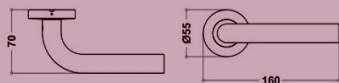

IMH-06

Design : Ø22mm
 Finish : Satin | Glossy
 Material : SS 304 | SS 316
 (Also available in Plate Type Mortise)

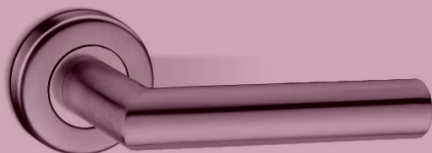
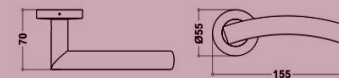

IMH-03

Design : Ø19mm | Ø22mm
 Finish : Satin | Glossy
 Material : SS 304 | SS 316
 (Also available in Plate Type Mortise)

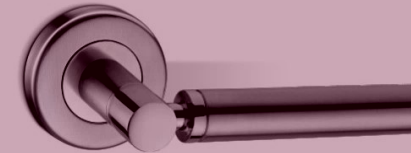
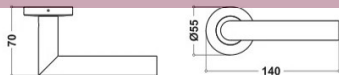

IMH-07

Design : Ø19mm
 Finish : Satin | Glossy
 Material : SS 304 | SS 316
 (Also available in Plate Type Mortise)



IMH-04

Design : Ø22mm
 Finish : Satin | Glossy
 Material : SS 304 | SS 316
 (Also available in Plate Type Mortise)



IMH-08

Design : Ø22mm
 Finish : Satin | Glossy
 Material : SS 304 | SS 316
 (Also available in Plate Type Mortise)

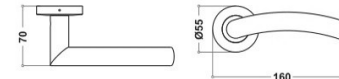

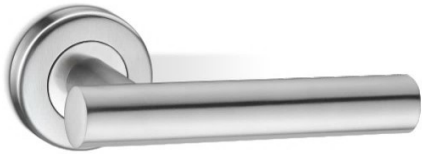

IMH-09

Design : Ø22mm
Finish : Satin | Glossy
Material : SS 304 | SS 316
(Also available in Plate Type Mortise)

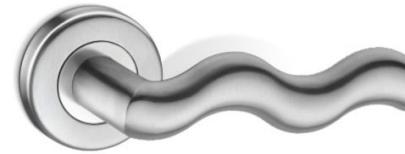
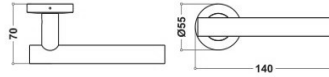

IMH-13

Design : Solid Casted
Finish : Satin | Glossy
Material : SS 304 | SS 316
(Also available in Plate Type Mortise)

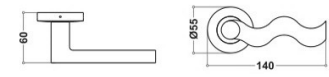

IMH-10

Design : Ø22mm
Finish : Satin | Glossy
Material : SS 304 | SS 316
(Also available in Plate Type Mortise)

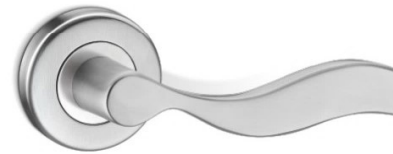
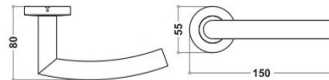

IMH-14

Design : Solid Casted
Finish : Satin | Glossy
Material : SS 304 | SS 316
(Also available in Plate Type Mortise)

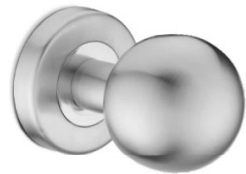
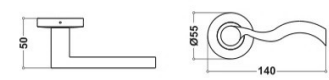

IMH-11

Design :
Finish : Satin | Glossy
Material : SS 304 | SS 316
(Also available in Plate Type Mortise)

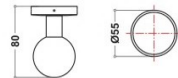

IMH-15

Design : Solid Casted
Finish : Satin | Glossy
Material : SS 304 | SS 316
(Also available in Plate Type Mortise)

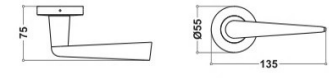

IMH-12

Design : 20mm Square Pipe
Finish : Satin | Glossy
Material : SS 304 | SS 316
(Also available in Plate Type Mortise)

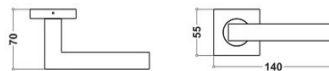

IMH-16

Design : Solid Casted
Finish : Satin | Glossy
Material : SS 304 | SS 316
(Also available in Plate Type Mortise)



**IMH-17**

Design : Solid Casted
 Finish : Satin | Glossy
 Material : SS 304 | SS 316
 (Also available in Plate Type Mortise)

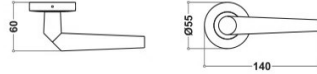
**IMH-21**

Design : Solid Casted
 Finish : Satin | Glossy
 Material : SS 304 | SS 316
 (Also available in Plate Type Mortise)

**IMH-18**

Design : Solid Casted
 Finish : Satin | Glossy
 Material : SS 304 | SS 316
 (Also available in Plate Type Mortise)

**IMH-22**

Design : Ø19mm | Solid Casted
 Finish : Satin | Glossy
 Material : SS 304 | SS 316
 (Also available in Plate Type Mortise)

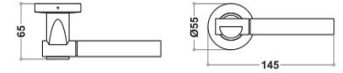
**IMH-19**

Design : Solid Casted
 Finish : Satin | Glossy
 Material : SS 304 | SS 316
 (Also available in Plate Type Mortise)

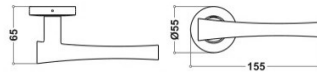
**IMH-23**

Design : Solid Casted
 Finish : Satin | Glossy
 Material : SS 304 | SS 316
 (Also available in Plate Type Mortise)

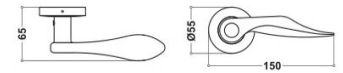
**IMH-20**

Design : Solid Casted
 Finish : Satin | Glossy
 Material : SS 304 | SS 316
 (Also available in Plate Type Mortise)

**IMH-24**

Design : Solid Casted
 Finish : Satin | Glossy
 Material : SS 304 | SS 316
 (Also available in Plate Type Mortise)

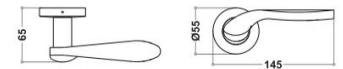



IMH-25

Design : Solid Casted
Finish : Satin | Glossy
Material : SS 304 | SS 316
(Also available in Plate Type Mortise)

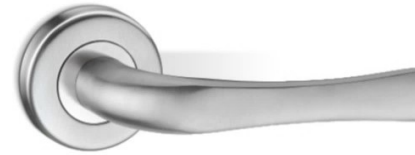
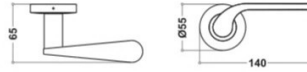

IMH-29

Design : Solid Casted
Finish : Satin | Glossy
Material : SS 304 | SS 316
(Also available in Plate Type Mortise)

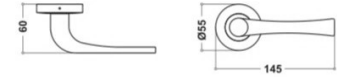

IMH-26

Design : Solid Casted
Finish : Satin | Glossy
Material : SS 304 | SS 316
(Also available in Plate Type Mortise)



IMH-30

Design : Solid Casted
Finish : Satin | Glossy
Material : SS 304 | SS 316
(Also available in Plate Type Mortise)

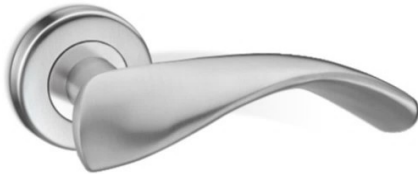
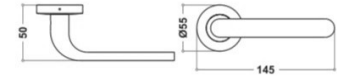

IMH-27

Design : Solid Casted
Finish : Satin | Glossy
Material : SS 304 | SS 316
(Also available in Plate Type Mortise)



IMH-31

Design : Solid Casted
Finish : Satin | Glossy
Material : SS 304 | SS 316
(Also available in Plate Type Mortise)

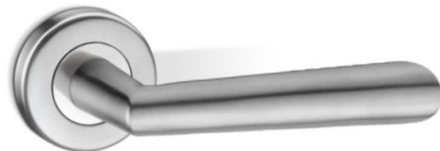
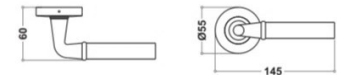

IMH-28

Design : Solid Casted
Finish : Satin | Glossy
Material : SS 304 | SS 316
(Also available in Plate Type Mortise)



IMH-32

Design : Solid Casted
Finish : Satin | Glossy
Material : SS 304 | SS 316
(Also available in Plate Type Mortise)



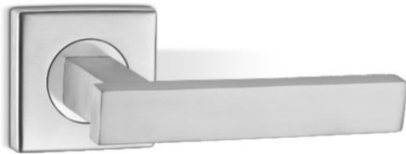

IMH-33

Design : Solid
Finish : Satin | Glossy
Material : SS 304 | SS 316
(Also available in Plate Type Mortise)

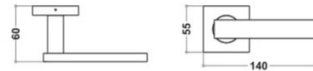

IMH-37

Design : Solid
Finish : Satin | Glossy
Material : SS 304 | SS 316
(Also available in Plate Type Mortise)



IMH-34

Design : Solid
Finish : Satin | Glossy
Material : SS 304 | SS 316
(Also available in Plate Type Mortise)



IMH-38

Design : Solid
Finish : Satin | Glossy
Material : SS 304 | SS 316
(Also available in Plate Type Mortise)

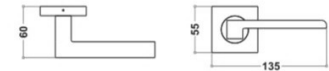

IMH-35

Design : Solid Casted
Finish : Satin | Glossy
Material : SS 304 | SS 316
(Also available in Plate Type Mortise)

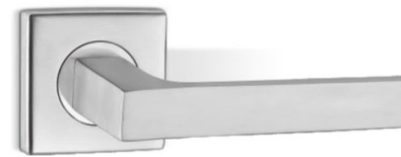
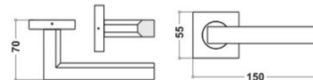

IMH-39

Design : Solid Casted
Finish : Satin | Glossy
Material : SS 304 | SS 316
(Also available in Plate Type Mortise)

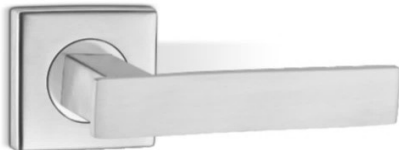
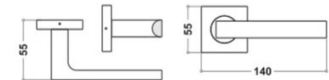

IMH-36

Design : Solid | 20mm Square
Finish : Satin | Glossy
Material : SS 304 | SS 316
(Also available in Plate Type Mortise)



IMH-40

Design : Solid Casted
Finish : Satin | Glossy
Material : SS 304 | SS 316
(Also available in Plate Type Mortise)

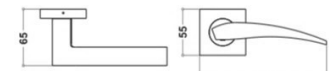



IMH-01-P

Design : With Plate Solid Casted
Finish : Satin | Glossy
Material : SS 304 | SS 316



IMH-03-P

Design : With Plate
Finish : Satin | Glossy
Material : SS 304 | SS 316



IMH-02-P

Design : With Plate
Finish : Satin | Glossy
Material : SS 304 | SS 316

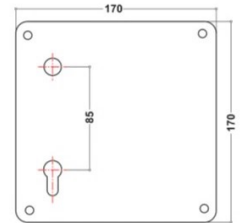

IMH-04-P

Design : With Plate
Finish : Satin | Glossy
Material : SS 304 | SS 316





IML-01

Mortise lock body with strike plate for wood door applied with mortise & cylinder

Finish : Satin | Black



Close Body



Stainless steel plate avoid rusting



Brass part for durability



Brass part for durability



IML-02

Mortise dead lock with strike plate for wood door applied with cylinder

Finish : Satin | Black



IML-03

Mortise baby latch with strike plate for wood door applied with cylinder

Finish : Satin | Black



IKH-01

Round Key Hole

Finish : Satin | Glossy

Material : SS 304 | SS 316



IKH-02

Square Key Hole

Finish : Satin | Glossy

Material : SS 304 | SS 316



IMC-01

Both Side Key Cylinder With Key



IMC-02

One Side Key & One Side Cylinder With Key



IMC-03

One Side Knob & One Side Screwdriver Part



IMC-04

Half Cylinder One Side Knob Only





IPH-01

Finish	Dia	Length
Satin	Ø22mm	200 to 300 mm
Combi		

Material : SS 304 & 316



IPH-02 (H Type)

Finish	Dia	Length
Satin	Ø22mm	200 to 450 mm
Combi	Ø25mm	300 to 600 mm
	Ø32mm	300 to 2400 mm

Material : SS 304 & 316

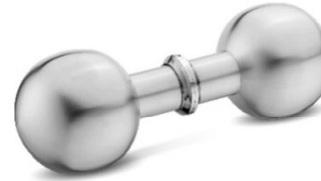

IPH-05

Finish	Dia	Length
Satin	Ø22mm	50 mm

Material : SS 304

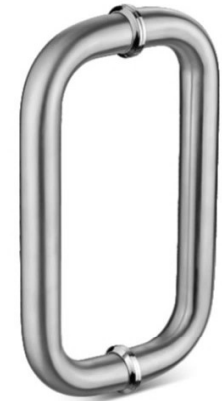

IPH-06 (D Type)

Finish	Dia	Length
Satin	Ø22mm	200 to 450 mm
Combi	Ø25mm	300 to 600 mm
	Ø32mm	300 to 2400 mm

Material : SS 304 & 316



IPH-03

Finish	Dia	Length
Satin	Ø19mm	200 to 300 mm
	Ø22mm	200 to 300 mm

Material : SS 304 & 316



IPH-04

Finish	Dia	Length
Satin	Ø22mm	200mm to 600mm
Combi		

Material : SS 316



IPH-07 (S Type)

Finish	Dia	Length
Satin	Ø22mm	200 to 300 mm
Combi		

Material : SS 304 & 316



IPH-08 (C Type)

Finish	Dia	Length
Satin	Ø22mm	200 to 300 mm
Combi		

Material : SS 304 & 316





IPH-09

Finish	Dia	Length
Satin	Ø22mm	200mm to 500mm
Combi	Ø25mm	200mm to 500mm

Material : SS 304 & 316



IPH-10

Finish	Dia	Length
Satin	Ø22mm	200mm to 600mm
Combi	Ø25mm	200mm to 600mm
	Ø32mm	300mm to 900mm

Material : SS 304 & 316



IPH-13

Finish	Dia	Length
Satin	Ø25mm	200 to 600 mm
Combi		

Material : SS 304 & 316

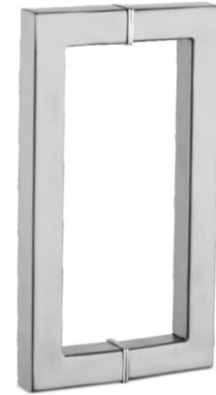

IPH-14

Finish	Dia	Length
Satin	Ø20mm	200 to 300 mm
Combi	Ø25mm	300 to 600 mm

Material : SS 304



IPH-11

Finish	Dia	Length
Satin	Ø22mm	200mm to 600mm
Combi		

Material : SS 304 & 316



IPH-12

Finish	Dia	Length
Satin	Ø22mm	200mm to 300mm
Combi		

Material : SS 304 & 316



IPH-15 (H Type adjustable)

Finish	Dia	Length
Satin	Ø25mm	200 to 600 mm
Combi		

Material : SS 304 & 316



IPH-16

Finish	Dia	Length
Satin	Ø22mm	200 to 600 mm
Combi	Ø25mm	200 to 600 mm

Material : SS 304





IPH-17 (H Type)

Finish	Dia	Length
Satin	∅20mm	200 to 300 mm
Combi	∅25mm	300 to 600 mm

Material : SS 304 & 316



IPH-18

Finish	Dia	Length
Satin	∅20mm	200 to 300 mm
Combi	∅25mm	300 to 600 mm

Material : SS 304 & 316



IPH-21

Finish	Dia	Length
Satin	20mm	200mm to 600mm
Combi	25mm	200mm to 600mm

Material : SS 304 & 316



IPH-22

Finish	Dia	Length
Satin	20mm	200mm to 600mm
Combi	25mm	200mm to 600mm

Material : SS 304 & 316



IPH-19

Finish	Dia	Length
Satin	∅	300 to 600 mm
Combi	15x30 Pipe	

Material : SS 304 & 316



IPH-20

Finish	Dia	Length
Satin	∅	300 to 600 mm
Combi	Pipe	

Material : SS 304 & 316



IPH-23

Shower glass door handle - round
(∅19mm pipe / ∅22mm pipe / ∅25mm pipe)
Finish : Satin / Glossy
Material : SS 304



IPH-24

Shower glass door handle - square
(∅20mm pipe / ∅25mm pipe)
Finish : Satin / Glossy
Material : SS 304





Ball Bearing Hirline Hinges

Size : 100 mm x 2.5 mm



Bearing Hinges (4 Bearing)

Size : 100 mm x 70 mm x 2.5 mm
 125 mm x 70 mm x 2.5 mm
 150 mm x 70 mm x 2.5 mm
 100 mm x 75 mm x 3.0 mm
 125 mm x 75 mm x 3.0 mm
 150 mm x 75 mm x 3.0 mm



FT Cutt Hinges

Size : 75 mm x 15 mm x 10 mm
 75 mm x 19 mm x 10 mm
 75 mm x 19 mm x 12 mm
 Flap thickness also available in 12 & 15 mm



L Hinges

Size : 75 mm x 10 mm x 6 mm
 75 mm x 10 mm x 12 mm
 75 mm x 10 mm x 18 mm
 75 mm x 12 mm x 6 mm
 75 mm x 12 mm x 12 mm
 75 mm x 12 mm x 18 mm
 75 mm x 19 mm x 6 mm
 75 mm x 19 mm x 12 mm
 75 mm x 19 mm x 18 mm
 Flap thickness also available in 12 & 15 mm



Bearing Hinges (2 Bearing)

Size : 75 mm x 70 mm x 2.5 mm
 100 mm x 70 mm x 2.5 mm
 125 mm x 70 mm x 2.5 mm
 150 mm x 70 mm x 2.5 mm
 75 mm x 75 mm x 3.0 mm
 100 mm x 75 mm x 3.0 mm
 125 mm x 75 mm x 3.0 mm
 150 mm x 75 mm x 3.0 mm



But Hinges

Size : 75 mm x 50 mm x 1.5 mm
 100 mm x 50 mm x 1.5 mm
 75 mm x 62 mm x 2.0 mm
 100 mm x 62 mm x 2.0 mm
 125 mm x 62 mm x 2.0 mm
 150 mm x 62 mm x 2.0 mm
 75 mm x 70 mm x 2.5 mm
 100 mm x 70 mm x 2.5 mm
 125 mm x 70 mm x 2.5 mm
 150 mm x 70 mm x 2.5 mm
 75 mm x 75 mm x 3.0 mm
 100 mm x 75 mm x 3.0 mm
 125 mm x 75 mm x 3.0 mm
 150 mm x 75 mm x 3.0 mm



Nero Hinges

Size : 75 mm x 15 mm x 15 mm
 75 mm x 13 mm x 13 mm
 Flap thickness also available in 12 & 15 mm



Lift Off Hinges

Size : 100 mm x 100 mm x 3 mm
 125 mm x 100 mm x 3 mm
 150 mm x 100 mm x 3 mm





Start Awesomeness

Change the atmosphere from corporate to creative by just adding our newly designed range of products. Leave behind the monotony of work hour and start a new sensational journey of aspiration. A whole new concept of glass fittings that is based on innovation, design genius and long-lasting quality standards.

Glass Concepts



IFS-1000

Finish : SS Satin | SS Glossy

Special Notes :
In areas likely to be subject to water our optional stainless steel cement box is available.
All our range of patch fittings, pivots and latches compliment the floor spring installation.

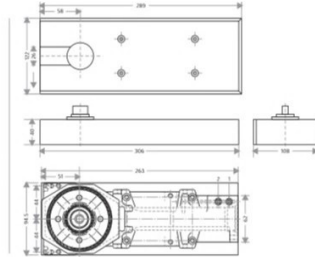

Technical Details

- About 100000 cycles tested
- Maximum door width 1000 mm
- Maximum door weight 100kg
- Non hold open for pool gates
- Cement box size
L - 275 mm, W - 108 mm, H - 40 mm
- Adjustment in cement box
L - 12 mm, W - 8 mm, H - 8 mm

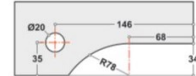

IPF-01

Top Patch

Finish : Satin

Material : Aluminium alloy body &
SS 304 grade cover plate



IPF-02

Bottom Patch

Finish : Satin

Material : Aluminium alloy body &
SS 304 grade cover plate

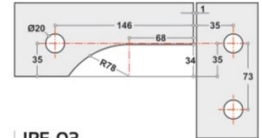

IPF-03

Over panel side panel patch with pivot (Big "L")

Finish : Satin

Material : Aluminium alloy body &
SS 304 grade cover plate



IFS-2000

Finish : SS Satin | SS Glossy

Special Notes :
In areas likely to be subject to water our optional stainless steel cement box is available.
All our range of patch fittings, pivots and latches compliment the floor spring installation.

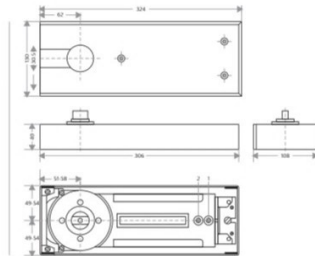

Technical Details

- About 100000 cycles tested
- Maximum door width 1200 mm
- Maximum door weight 150kg
- Non hold open for pool gates
- Cement box size
L - 306 mm, W - 108 mm, H - 40 mm
- Adjustment in cement box
L - 10 mm, W - 5 mm, H - 5 mm

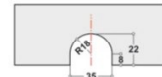

IPF-04

Aluminium fixed floor

Finish : Satin

Material : Aluminium alloy body &
SS 304 grade cover plate

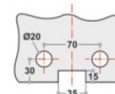

IPF-05

Glass to glass aluminium fixed floor

Finish : Satin

Material : Aluminium alloy body &
SS 304 grade cover plate

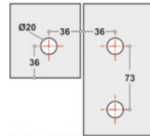

IPF-06

Over panel side panel patch (Small "L")
 Finish : Satin
 Material : Aluminium alloy body & SS 304 grade cover plate

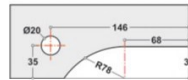

IPF-07

Over panel patch with pivot & wall
 Finish : Satin
 Material : Aluminium alloy body & SS 304 grade cover plate

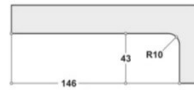

IPF-08

Patch lock
 Finish : Satin
 Material : Aluminium alloy body & SS 304 grade cover plate

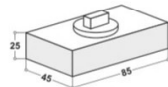

IPF-09

Bottom bearing patch pivot
 Finish : Satin
 Material : SS 304 grade & M.S.



IPF-10

Top patch pivot
 Finish : Satin
 Material : SS 304 grade



IGC-01

Fixed floor mounting - Casting
 Finish : Satin | Glossy
 Material : SS 304 & 316 grade

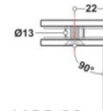

IGC-02

Wall to glass connector 90°-Casting
 Finish : Satin | Glossy
 Material : SS 304 & 316 grade

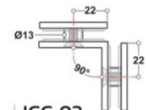

IGC-03

Glass to glass connector 90°-Casting
 Finish : Satin | Glossy
 Material : SS 304 & 316 grade

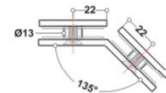

IGC-04

Glass to glass connector 135°-Casting
 Finish : Satin | Glossy
 Material : SS 304 & 316 grade

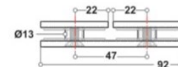

IGC-05

Glass to glass connector 180°-Casting
 Finish : Satin | Glossy
 Material : SS 304 & 316 grade





IGC-06

Fixed floor mounting
4 mm sheet metal
Finish : Satin | Glossy
Material : SS 304 & 316 grade

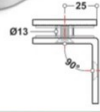

IGC-07

Wall to glass connector 90°
4 mm sheet metal
Finish : Satin | Glossy
Material : SS 304 & 316 grade



IGC-12

Fixed floor mounting
3 mm sheet metal
Finish : Satin | Glossy
Material : SS 304 & 316 grade

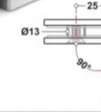

IGC-13

Wall to glass connector 90°
3 mm sheet metal
Finish : Satin | Glossy
Material : SS 304 & 316 grade

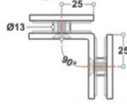
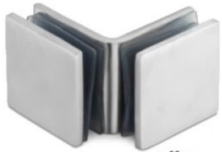

IGC-08

Glass to glass connector 90°
4 mm sheet metal
Finish : Satin | Glossy
Material : SS 304 & 316 grade

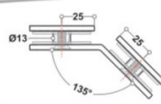

IGC-09

Glass to glass connector 135°
4 mm sheet metal
Finish : Satin | Glossy
Material : SS 304 & 316 grade

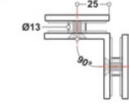
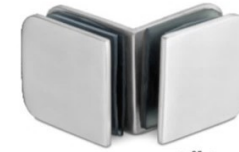

IGC-14

Glass to glass connector 90°
3 mm sheet metal
Finish : Satin | Glossy
Material : SS 304 & 316 grade

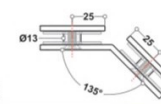

IGC-15

Glass to glass connector 135°
3 mm sheet metal
Finish : Satin | Glossy
Material : SS 304 & 316 grade

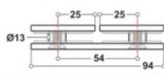

IGC-10

Glass to glass connector 180°
4 mm sheet metal
Finish : Satin | Glossy
Material : SS 304 & 316 grade

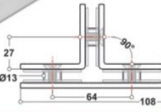

IGC-11

Glass to glass connector three way 90°
4 mm sheet metal
Finish : Satin | Glossy
Material : SS 304 & 316 grade

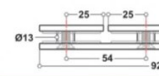

IGC-16

Glass to glass connector 180°
4 mm sheet metal
Finish : Satin | Glossy
Material : SS 304 & 316 grade

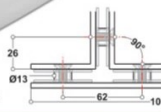

IGC-17

Glass to glass connector three way 90°
3 mm sheet metal
Finish : Satin | Glossy
Material : SS 304 & 316 grade



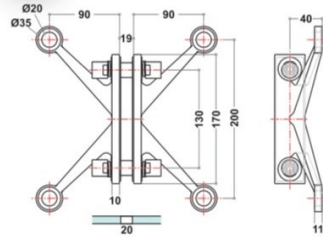

ISF-01

Four way fin type spider

Finish : Satin | Glossy

Material : SS 316 Grade

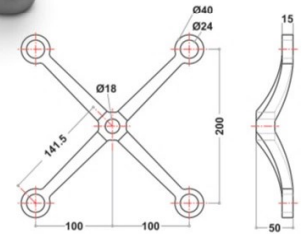

ISF-03

Four way fin type spider

Finish : Satin | Glossy

Material : SS 316 Grade

ISF-02

Two way fin type spider

Finish : Satin | Glossy

Material : SS 316 Grade

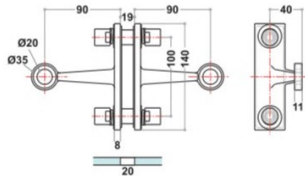

ISF-04

Three way fin type spider

Finish : Satin | Glossy

Material : SS 316 Grade

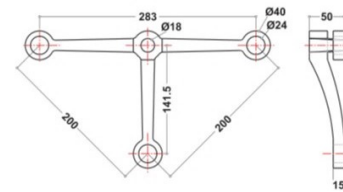

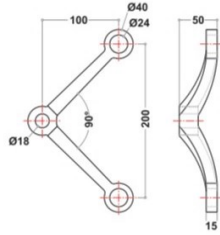

ISF-05

Two way point type spider 90°

Finish : Satin | Glossy

Material : SS 316 Grade

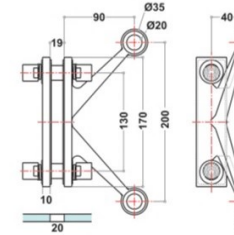

ISF-08

Two way fin type spider 90°

Finish : Satin | Glossy

Material : SS 316 Grade

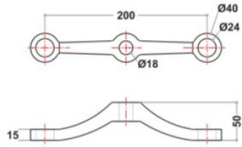

ISF-06

Two way point type spider 180°

Finish : Satin | Glossy

Material : SS 316 Grade

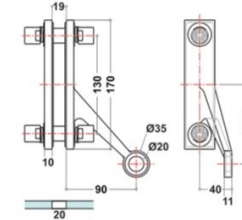

ISF-09

One way fin type spider right side 45°

Finish : Satin | Glossy

Material : SS 316 Grade

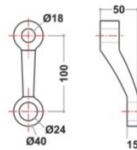

ISF-07

One way point type spider

Finish : Satin | Glossy

Material : SS 316 Grade

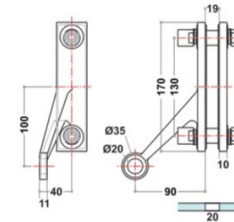

ISF-10

One way fin type spider left side 45°

Finish : Satin | Glossy

Material : SS 316 Grade



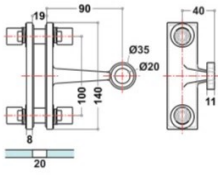

ISF-II

One way fin type spider 90°
 Finish : Satin | Glossy
 Material : SS 316 Grade

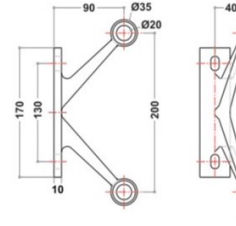

ISF-13

Two way spider
 Finish : Satin | Glossy
 Material : SS 316 Grade

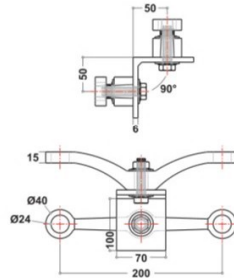

ISF-12

Four way spider 90°
 Finish : Satin | Glossy
 Material : SS 316 Grade

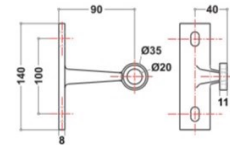

ISF-14

One way spider
 Finish : Satin | Glossy
 Material : SS 316 Grade



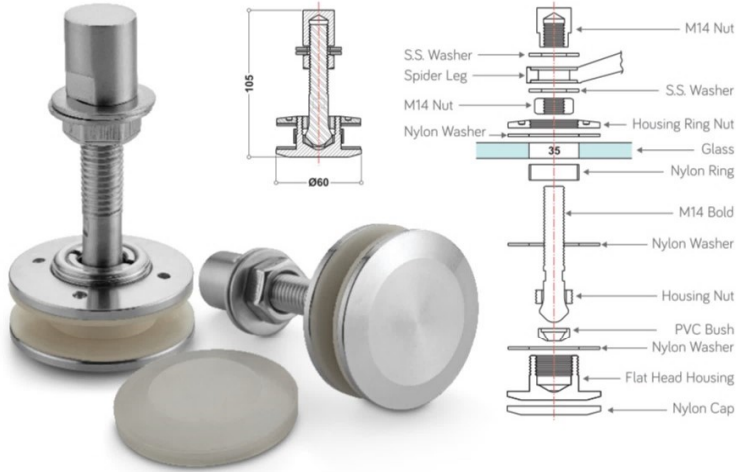

IRF-01

Articulated routel
 Finish : Satin | Glossy
 Material : SS 304 Grade

IRF-02

Articulated routel
 Finish : Satin | Glossy
 Material : SS 304 Grade



IRF-03

Fix head routel
 Finish : Satin | Glossy
 Material : SS 304 Grade

IRF-04

Fix heading routel
 Finish : Satin | Glossy
 Material : SS 304 Grade

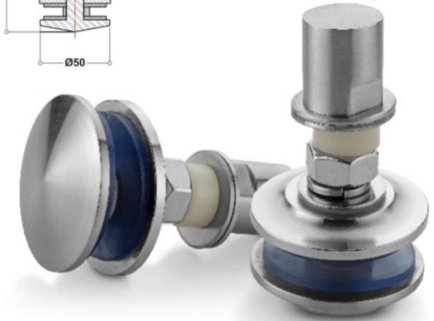
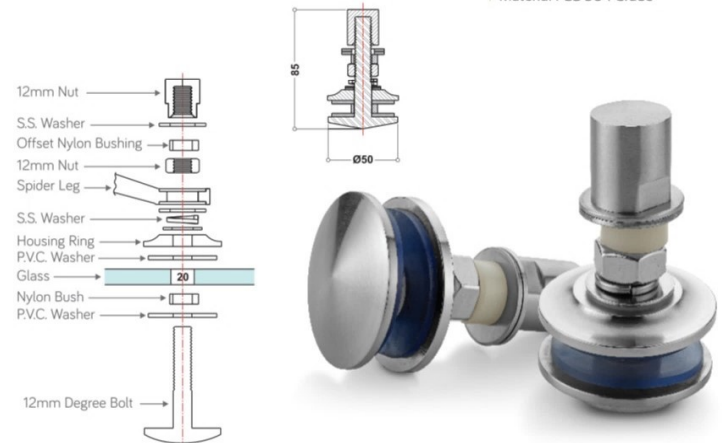
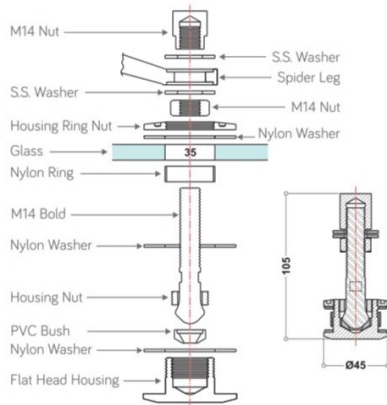



IRF-05

Countersunk routel
 Finish : Satin | Glossy
 Material : SS 304 Grade

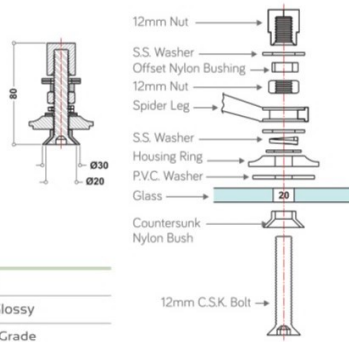

IFP-01

Fin plate
 Finish : Satin | Glossy
 Material : SS 304 Grade

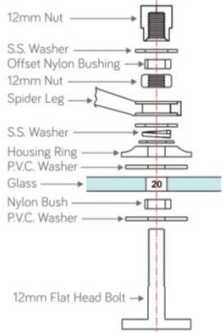
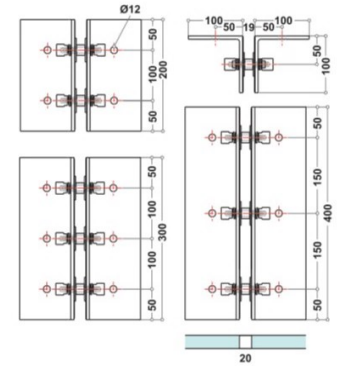

IRF-06

Fix head routel
 Finish : Satin | Glossy
 Material : SS 304 Grade



ISP-01

Splice plate
 Finish : Satin | Glossy
 Material : SS 304 Grade

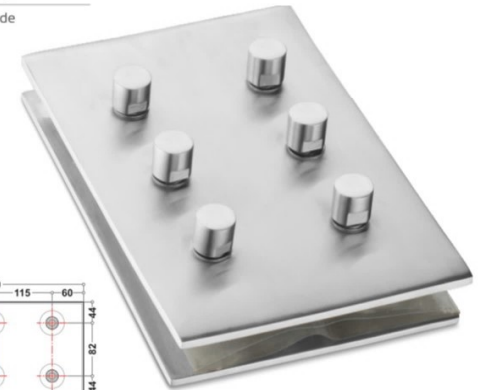
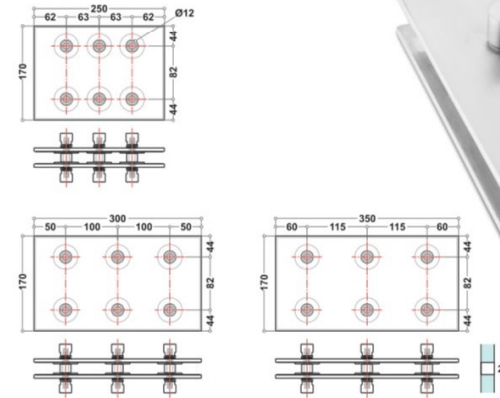

ASB-01

Point type spider fitting bold
 Finish : Satin | Glossy
 Material : SS 304 Grade

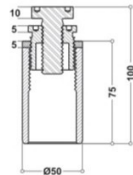

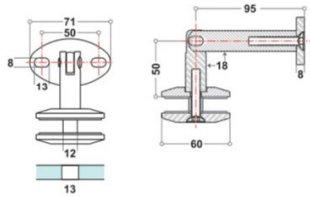

ICF-01

Hold glass with the wall at 90°

Finish : Satin | Glossy

Material : SS 304 Grade

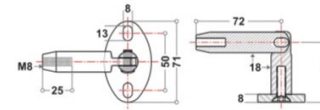

ICF-03

Hold the cable or rod with the wall be used as a pair with ICF-02

Finish : Satin | Glossy

Material : SS 304 Grade

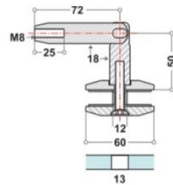

ICF-02

Hold canopy glass with cable or rod along with ICF-03

Finish : Satin | Glossy

Material : SS 304 Grade

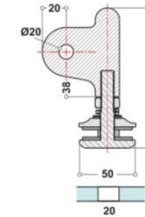

ICF-04

Hold glass for canopy with cable or rod with ICF-05

Finish : Satin | Glossy

Material : SS 304 Grade

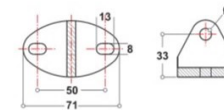

ICF-05

Hold the cable or rod with the wall be used as a pair with ICF-04

Finish : Satin | Glossy

Material : SS 304 Grade



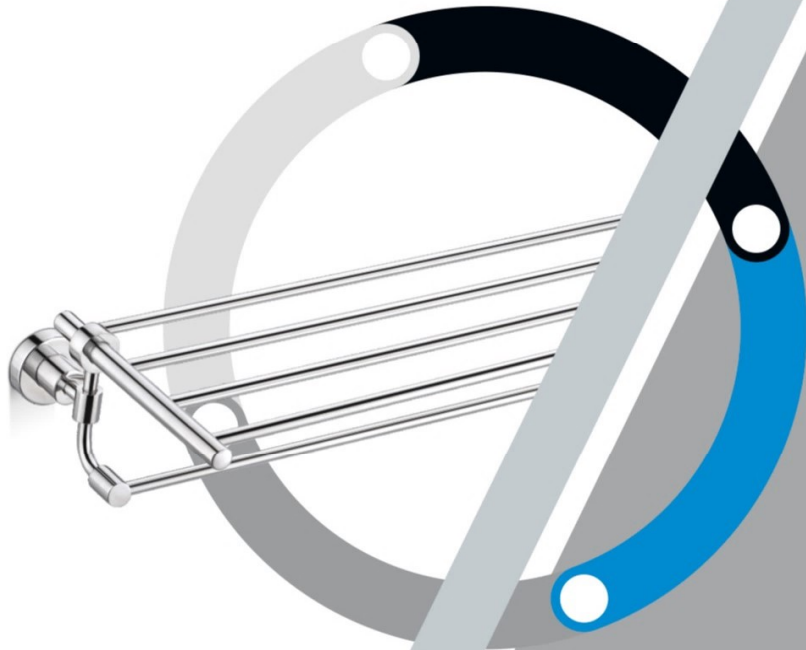

Begin 
Awesomeness

Turn on your senses with some smartly designed space. Thanks to our exquisite range of bath concepts, your personal space will also get the fresh new look just as you do. Every morning will acquire a new meaning with this latest generation of bath accessories that speaks a lot about not just about your love for the style but also about your status.

Bath Concepts

desire



TOWEL RACK WITH ROD

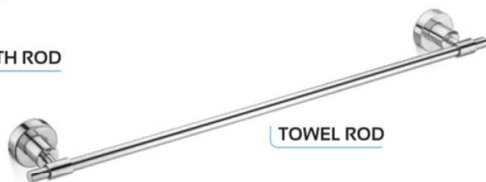

TOWEL ROD



SOAP DISH



ROBE HOOK



NAPKIN RING



LIQUID DISPENSER



TOOTHBRUSH HOLDER



PAPER HOLDER

spring

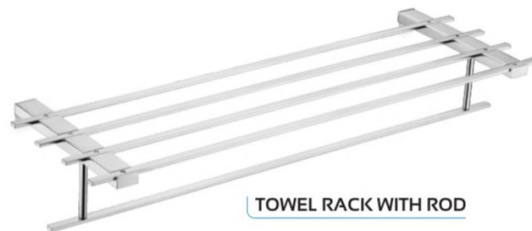

TOWEL RACK WITH ROD



TOWEL ROD

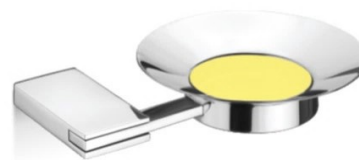

SOAP DISH



ROBE HOOK



LIQUID DISPENSER



NAPKIN RING



TOOTHBRUSH HOLDER



PAPER HOLDER



canes



TOWEL RACK WITH ROD



TOWEL ROD



SOAP DISH



ROBE HOOK



LIQUID DISPENSER



NAPKIN RING



PAPER HOLDER



TOOTHBRUSH HOLDER

feiro

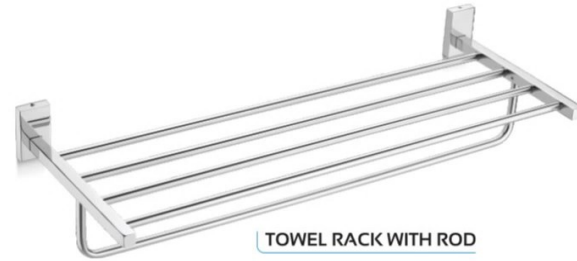

TOWEL RACK WITH ROD



TOWEL ROD



SOAP DISH



ROBE HOOK



LIQUID DISPENSER



NAPKIN RING



PAPER HOLDER



TOOTHBRUSH HOLDER



feista



TOWEL RACK WITH ROD

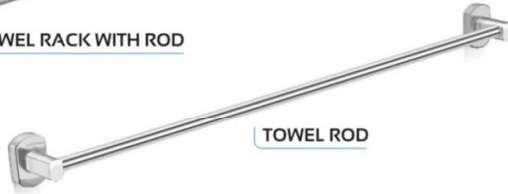

TOWEL ROD



SOAP DISH



LIQUID DISPENSER



TOOTHBRUSH HOLDER



PAPER HOLDER

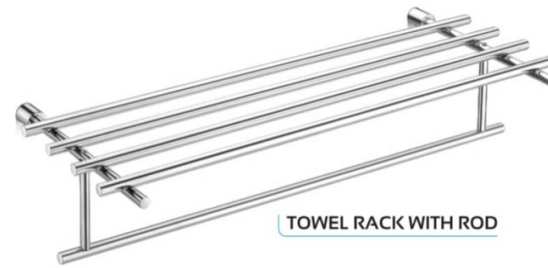

TOWEL RACK WITH ROD



TOWEL ROD



SOAP DISH



LIQUID DISPENSER



ROBE HOOK



NAPKIN RING



PAPER HOLDER



TOOTHBRUSH HOLDER

dove





Climb 
Awesomeness

Your ascent towards elite needs a stylish and solid support. That's what our most fashionable range of stair concepts provides. Built from the best raw material at our highly sophisticated production facility, this range gives you wider scope of choice and better value for your money. Perfected through stringent quality checks, it will level up the quality of life.

Stair Concepts

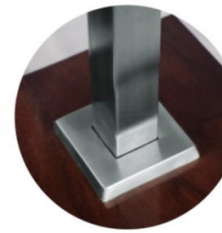
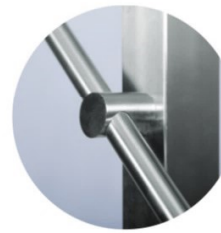

AVAILABLE UNITS

Height	<input checked="" type="checkbox"/> 840mm	<input checked="" type="checkbox"/> 915mm	<input checked="" type="checkbox"/> 1015mm
Grade	<input checked="" type="checkbox"/> 304	<input checked="" type="checkbox"/> 316	
Polishing	<input checked="" type="checkbox"/> Satin	<input checked="" type="checkbox"/> Glossy	<input checked="" type="checkbox"/> Combi
Handrail	<input checked="" type="checkbox"/> 38mm	<input checked="" type="checkbox"/> 50mm	
Horizontal	<input checked="" type="checkbox"/> 12mm	<input checked="" type="checkbox"/> 16mm	<input checked="" type="checkbox"/> 19mm
Balustrade	<input checked="" type="checkbox"/> 40x40mm	<input checked="" type="checkbox"/> 50x50mm	
Glass	<input checked="" type="checkbox"/> 10mm	<input checked="" type="checkbox"/> 12mm	



IROO2

ROUND BALUSTRADE

with horizontal members or glass

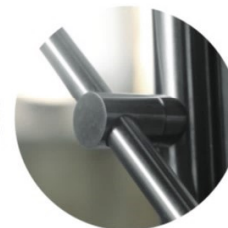

AVAILABLE UNITS

Height	<input checked="" type="checkbox"/> 840mm	<input checked="" type="checkbox"/> 915mm	<input checked="" type="checkbox"/> 1015mm
Grade	<input checked="" type="checkbox"/> 304	<input checked="" type="checkbox"/> 316	
Polishing	<input checked="" type="checkbox"/> Satin	<input checked="" type="checkbox"/> Glossy	<input checked="" type="checkbox"/> Combi
Handrail	<input checked="" type="checkbox"/> 38mm	<input checked="" type="checkbox"/> 50mm	
Horizontal	<input checked="" type="checkbox"/> 12mm	<input checked="" type="checkbox"/> 16mm	<input checked="" type="checkbox"/> 19mm
Balustrade	<input checked="" type="checkbox"/> 38mm	<input checked="" type="checkbox"/> 50mm	
Glass	<input checked="" type="checkbox"/> 10mm	<input checked="" type="checkbox"/> 12mm	



IRO03

RETANGLE BALUSTRADE

with horizontal members or glass

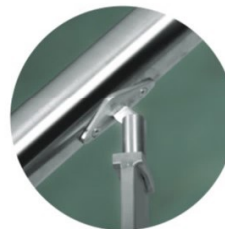

AVAILABLE UNITS

Height	<input checked="" type="checkbox"/> 840mm	<input checked="" type="checkbox"/> 915mm	<input checked="" type="checkbox"/> 1015mm
Grade	<input checked="" type="checkbox"/> 304	<input checked="" type="checkbox"/> 316	
Polishing	<input checked="" type="checkbox"/> Satin	<input checked="" type="checkbox"/> Glossy	<input checked="" type="checkbox"/> Combi
Handrail	<input checked="" type="checkbox"/> 38mm	<input checked="" type="checkbox"/> 50mm	
Horizontal	<input checked="" type="checkbox"/> 12mm	<input checked="" type="checkbox"/> 16mm	<input checked="" type="checkbox"/> 19mm
Balustrade	<input checked="" type="checkbox"/> 12x50mm (Solid & Hollow)	<input checked="" type="checkbox"/> 25x50mm	<input checked="" type="checkbox"/> 50x100mm
Glass	<input checked="" type="checkbox"/> 10mm	<input checked="" type="checkbox"/> 12mm	



IRO04

OVAL

side mounting with glass

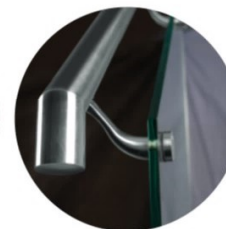
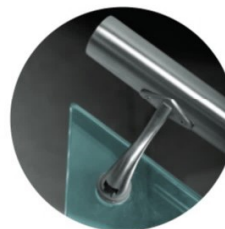

AVAILABLE UNITS

Height	<input checked="" type="checkbox"/> 840mm	<input checked="" type="checkbox"/> 915mm	<input checked="" type="checkbox"/> 1015mm
Grade	<input checked="" type="checkbox"/> 304	<input checked="" type="checkbox"/> 316	
Polishing	<input checked="" type="checkbox"/> Satin	<input checked="" type="checkbox"/> Glossy	
Handrail	<input checked="" type="checkbox"/> 38mm	<input checked="" type="checkbox"/> 50mm	
Glass	<input checked="" type="checkbox"/> 12mm	<input checked="" type="checkbox"/> 15mm	



IRO05

ROUND

side mounting with glass

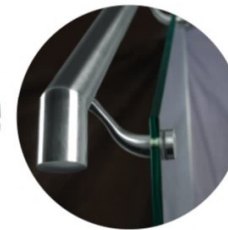
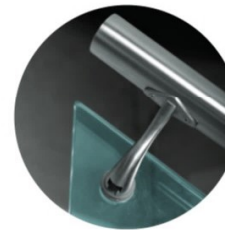

AVAILABLE UNITS

Height	<input checked="" type="checkbox"/> 840mm	<input checked="" type="checkbox"/> 915mm	<input checked="" type="checkbox"/> 1015mm
Grade	<input checked="" type="checkbox"/> 304	<input checked="" type="checkbox"/> 316	
Polishing	<input checked="" type="checkbox"/> Satin	<input checked="" type="checkbox"/> Glossy	
Handrail	<input checked="" type="checkbox"/> 38mm	<input checked="" type="checkbox"/> 50mm	
Glass	<input checked="" type="checkbox"/> 12mm	<input checked="" type="checkbox"/> 15mm	



FR006

FLAT BAR

top mounting with glass

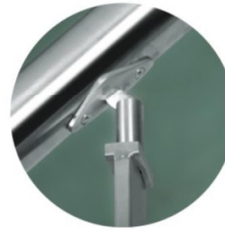

AVAILABLE UNITS

Height	<input checked="" type="checkbox"/> 840mm	<input checked="" type="checkbox"/> 915mm	<input checked="" type="checkbox"/> 1015mm
Grade	<input checked="" type="checkbox"/> 304	<input checked="" type="checkbox"/> 316	
Polishing	<input checked="" type="checkbox"/> Satin	<input checked="" type="checkbox"/> Glossy	<input checked="" type="checkbox"/> Combi
Handrail	<input checked="" type="checkbox"/> 38mm	<input checked="" type="checkbox"/> 50mm	
Balustrade	<input checked="" type="checkbox"/> 10x50mm (Solid)	<input checked="" type="checkbox"/> 12x50mm (Solid)	<input checked="" type="checkbox"/> 12x40mm (Solid)
Glass	<input checked="" type="checkbox"/> 10mm	<input checked="" type="checkbox"/> 12mm	



IR007

DUO BALUSTRADE
top mounting with glass

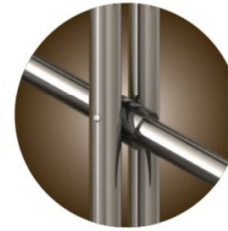
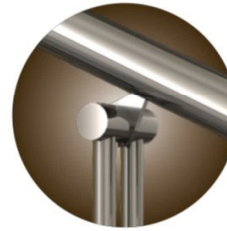
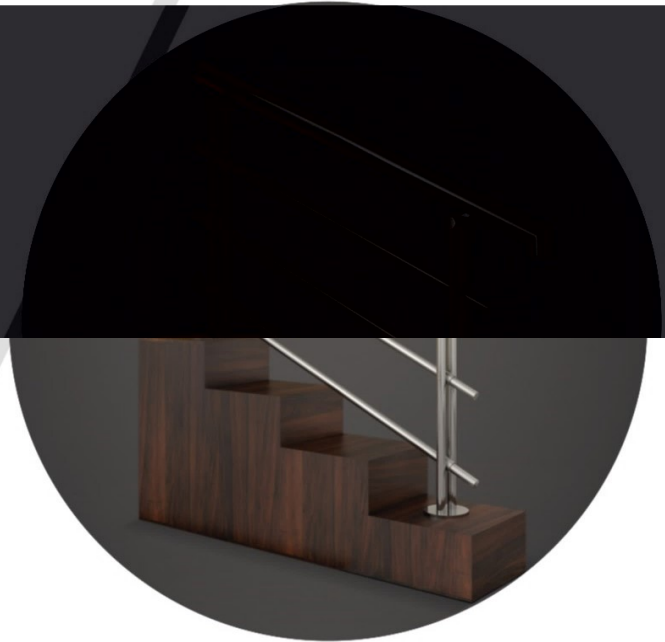

AVAILABLE UNITS

Height	<input checked="" type="checkbox"/> 840mm	<input checked="" type="checkbox"/> 915mm	<input checked="" type="checkbox"/> 1015mm
Grade	<input checked="" type="checkbox"/> 304	<input checked="" type="checkbox"/> 316	
Polishing	<input checked="" type="checkbox"/> Satin	<input checked="" type="checkbox"/> Glossy	<input checked="" type="checkbox"/> Combi
Handrail	<input checked="" type="checkbox"/> 38mm	<input checked="" type="checkbox"/> 50mm	
Balustrade	<input checked="" type="checkbox"/> 25*25mm (Pipe)		
Glass	<input checked="" type="checkbox"/> 10mm	<input checked="" type="checkbox"/> 12mm	
Horizontal	<input checked="" type="checkbox"/> 12mm	<input checked="" type="checkbox"/> 16mm	

IRO08

HALF BALUSTRADE

top mounting with glass

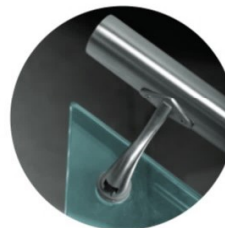

AVAILABLE UNITS

Height	<input checked="" type="checkbox"/> 840mm	<input checked="" type="checkbox"/> 915mm	<input checked="" type="checkbox"/> 1015mm
Grade	<input checked="" type="checkbox"/> 304	<input checked="" type="checkbox"/> 316	
Polishing	<input checked="" type="checkbox"/> Satin	<input checked="" type="checkbox"/> Glossy	
Handrail	<input checked="" type="checkbox"/> 38mm	<input checked="" type="checkbox"/> 50mm	
Balustrade	<input checked="" type="checkbox"/> 40x40mm	<input checked="" type="checkbox"/> 10x50mm (Solid)	<input checked="" type="checkbox"/> 12x40mm (Solid)
Glass	<input checked="" type="checkbox"/> 12mm	<input checked="" type="checkbox"/> 15mm	



Accessories



Bend Pieces



Glass Spigots



Base Covers



Base Plates



Glass Brackets



Handrail T-Supports



Brackets



Endcaps & Covers



Anchor Bolt, Screw & etc..

Chemical Composition

Element %	304 Grade	316 Grade	Implications
Carbon	0.08	0.08	Increase in percentage decreases the corrosion resistance.
Silicon	1.00	1.00	-
Manganese	2.00	2.00	Affects the magnetic characteristic and hardness of Iron
Phosphorus	0.045	0.045	-
Sulphur	0.03	0.03	-
Chromium	18.0 to 20.0	16.0 to 18.0	Addition of 12% forms stainless steel from ordinary steel. Removes the corrosive effect of Carbon. Forms a passive film which prevents oxidation & consequent corrosion.
Molybdenum (MOLY)	Nil	2 to 3	Molybdenum increases the corrosion resistance to chlorides and sulphates including sulfurous acids in pulp industries. It has a superior tensile strength at high temperature as compared to 304 Grade steel. This element can resist major chemical reaction and thus being a very costly element.
Nickel	8.0 to 10.5	10.0 to 14.0	Nickel provides corrosion resistance, increases strength in both high & low temperature, increases toughness in low temperature and lowers the effects of work hardening. Thus higher percentage makes the steel superior in quality.

Our Reputed Clients

